

# B2900B/BL Series Precision Source/Measure Unit

Cost-effective source/measurement solutions offer superior performance



## Configure Your Keysight B2900B/BL Series Precision Source/Measure Unit

The Keysight B2900B/BL Series Source/Measure Unit (SMU) series contains the following six models.

- B2901BL Precision Source/Measure Unit, 1 ch, 1pA resolution, 21 V, 1.5 A
- B2910BL Precision Source/Measure Unit, 1 ch, 10fA resolution, 210 V, 1.5 A
- B2901B Precision Source/Measure Unit, 1 ch, 100fA resolution, 210 V, 3A DC/10.5 A pulse
- B2902B Precision Source/Measure Unit, 2 ch, 100fA resolution, 210 V, 3A DC/10.5 A pulse
- B2911B Precision Source/Measure Unit, 1 ch, 10fA resolution, 210 V, 3A DC/10.5 A pulse
- B2912B Precision Source/Measure Unit, 2 ch, 10fA resolution, 210 V, 3A DC/10.5 A pulse

This configuration guide has step-by-step instructions to help you configure an SMU and its related accessories to meet specific test requirements. For detailed specifications, refer to the [B2900B/BL SMU series data sheet](#).

### Step 1. Select B2900B/BL Series model

There are two key parameters you need to select up-front: the number of measurement channels (one or two) and the SMU performance level. The B2900B/BL series comes in value (B2901BL/B2910BL), standard (B2901B/B2902B) and high-performance (B2911B/B2912B) versions.

Note: After purchase it is not possible to upgrade an SMU to have more channels or to the other version.

Product number	Number of channels	Max Output		Min source resolution	Min measure resolution	Min timing interval	Viewing mode
		DC	Pulse				
B2901BL	1	21 V	N/A	10 pA	1 pA	200 µs	Single, graph
		1.5 A		1 µV	100 nV		
B2910BL	1	210 V	N/A	100 fA	10 fA	50 µs	Single, graph
		1.5 A		1 µV	100 nV		
B2901B	1	210 V	200 V	1 pA	100 fA	20 µs	Single, graph
		3.03 A	10.5 A	1 µV	100 nV		
B2902B	2	210 V	200 V	1 pA	100 fA	20 µs	Single, dual, graph
		3.03 A	10.5 A	1 µV	100 nV		
B2911B	1	210 V	200 V	10 fA	10 fA	10 µs	Single, graph, roll
		3.03 A	10.5 A	100 nV	100 nV		
B2912B	2	210 V	200 V	10 fA	10 fA	10 µs	Single, dual, graph, roll
		3.03 A	10.5 A	100 nV	100 nV		

The following items are supplied standard with each B2900B/BL series SMU:

	Description	Qty.	Additional information
1	Quick Reference	1ea	Printed reference for quick startup (English)
2	Certificate of Calibration (without test data)	1ea	Certificate of calibration (without actual test data). If you need the test data, please specify option UK6.
3	USB cable	1ea	USB cable (1.8 m). Orderable parts number is 8121-1696.

## Step 2. Select optional accessories

### Step 2-1. Choose a rack mount kit (optional)

Description	Product number	Additional information
Rack Mount Kit	1CM124A	Includes a rack mount flange and front handle kit. Fits standard 19-inch rack and occupies two units of rack space.

### Step 2-2. Determine if you need to make 4-wire or guarded measurements

The B2900B/BL SMUs support both 2-wire and 4-wire measurement. The default connection scheme is the simpler 2-wire configuration, which uses only the force terminals. In 2-wire mode the sense terminals are left open.

If you are measuring very small resistances or applying very large currents then you should use the 4-wire measurement method (also known as the Kelvin method). This technique uses both the force and sense terminals, and by making the measurement through the sense terminals (in which no current is flowing) the effects of cable resistance are eliminated.

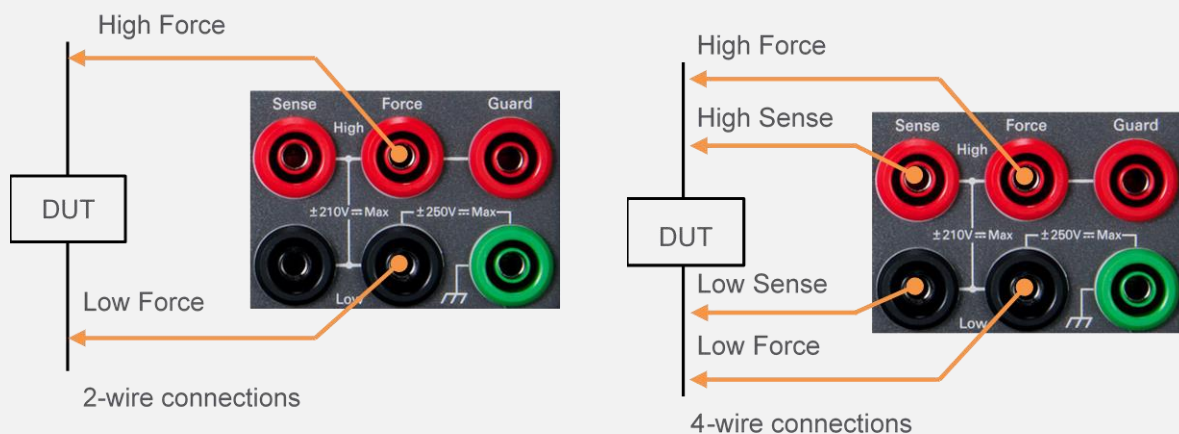

Low current measurements ( $< 1 \text{ nA}$ ) require guarding to prevent leakage through the measurement cable. The schematic shown below provides a simplified overview of the guarding technique. Guarded measurements require the use of triaxial cables. A follower (x1) buffer amplifier keeps the guard conductor at the same potential as the center conductor. Since there is no voltage difference, no current can flow from the center conductor to the guard.

Note: In this example, even the test fixture has a guarded shield to prevent leakage at the test fixture.

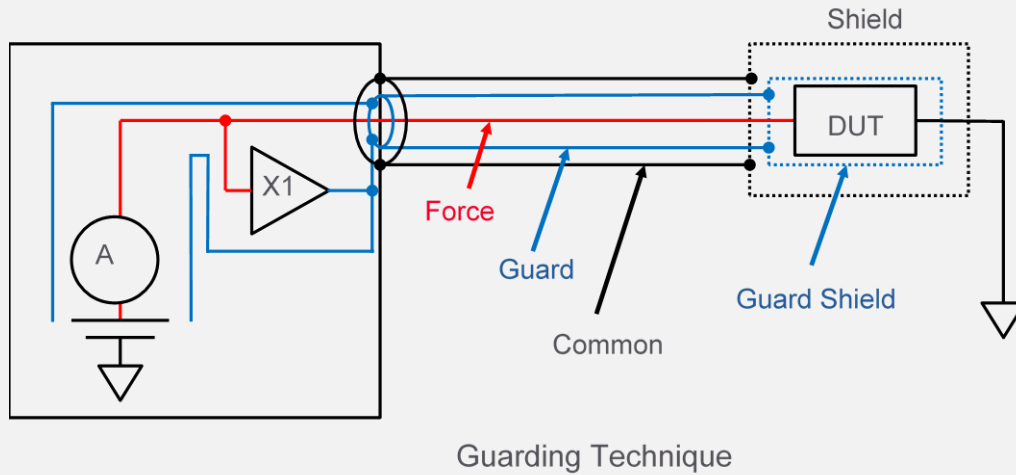

1. Unguarded 2-Wire connection scheme

	Recommended connection		Easy connection	
Typical connection example			<p>The 11059A simplifies connectivity but does not support voltage magnitudes greater than <math>\pm 42</math> V.</p>	
Recommended accessories	U8201A	Combo test lead kit	11059A	Kelvin probe set

## 2. Unguarded 4-Wire connection scheme

Recommended connection		Easy connection	
Typical connection example			
Recommended accessories	U8201A	Combo test lead kit	11059A Kelvin probe set

The 11059A simplifies connectivity but does not support voltage magnitudes greater than  $\pm 42$  V.

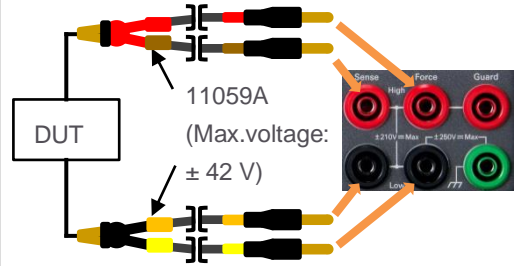

## 3. Guarded 2-Wire connection scheme

Recommended connection						
Typical connection example	<p>The N1295A does not support Voltages greater than <math>\pm 42</math> V.</p>			<p>The 16442B supports Voltages up to 200 V.</p>		
Recommended accessories	16494A-001	2ea	Low leakage Triaxial cable (1.5 m)	16494A-001	2ea	Low leakage Triaxial cable
	N1297A	1ea	Banana - Triaxial Adapter for 2-wire (non-Kelvin) connection	N1297A	1ea	Banana - Triaxial Adapter for 2-wire (non-Kelvin) connection
	N1295A	1ea	Device/component test fixture	16442B	1ea	Test Fixture for general use

#### 4. Guarded 4-Wire connection scheme

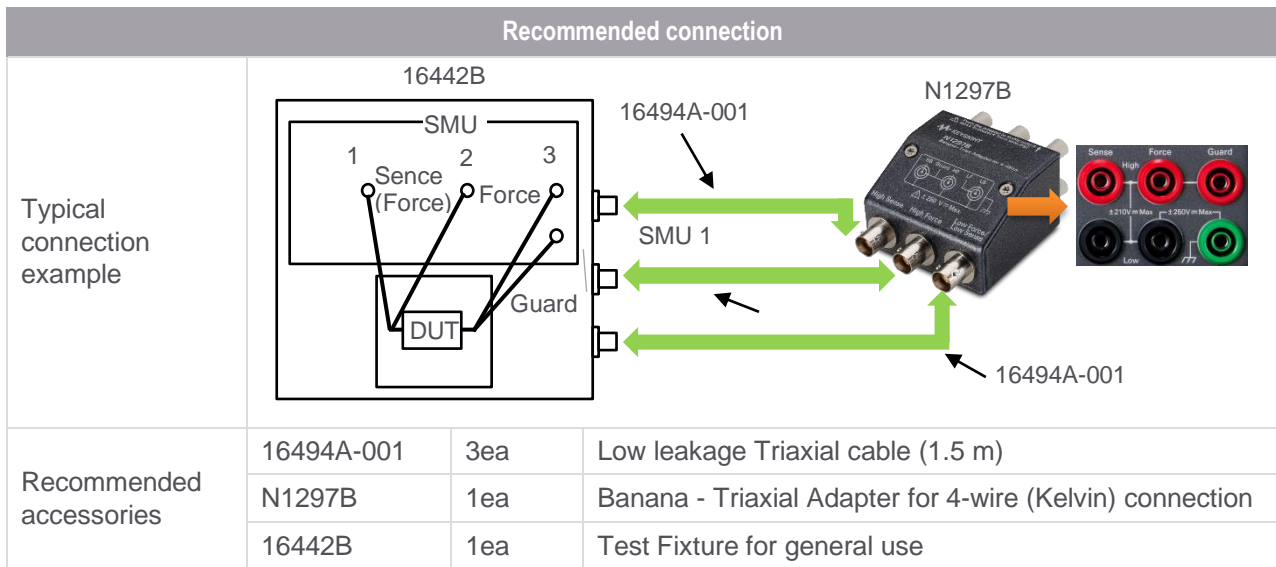

#### Step 2-3. Consider interlock circuit (optional)

To prevent accidental exposure to dangerously high voltages, the SMUs have a safety interlock. They cannot source voltages greater than  $\pm 42$  V unless the interlock circuit is closed. This is achieved using pins 16 and 24 on the rear Digital I/O output. Normally, these pins are routed to a shielding box or test fixture that must be closed to complete the interlock circuit.

If you are using the 16442B test fixture then you can use the N1294A-011 or 012 interlock cables to connect to the interlock circuit. If you are not using the 16442B then you should install an interlock circuit as shown in the figure below. For more detailed information, please refer to “Installing the Interlock Circuit” in the Keysight Series User’s Guide.

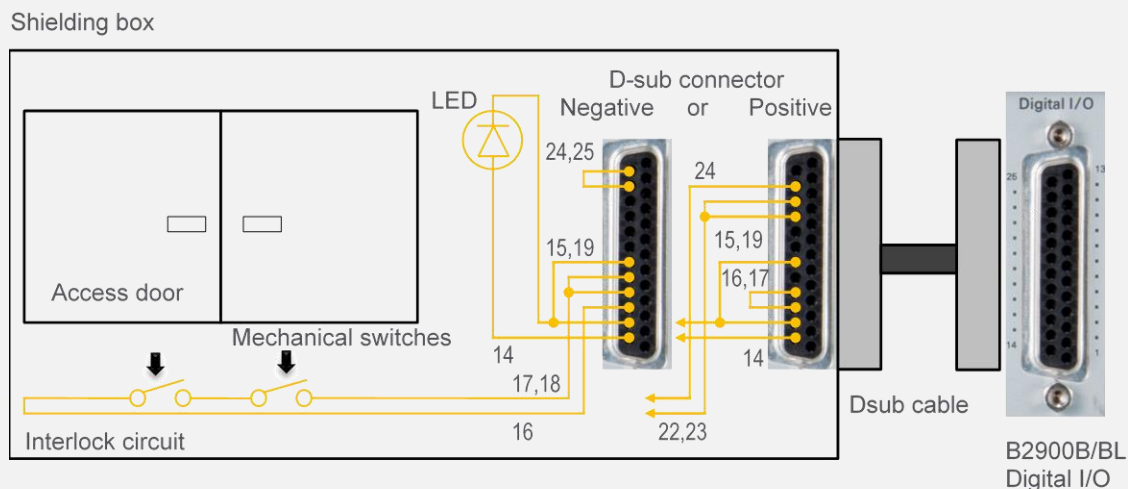

Description	Product number	Description
Interlock cable (1.5 m)	N1294A-011	Interlock cable for the 16442A/B test fixture (GPIO Dsub-25 to 6-pin mini plug)
Interlock cable (3.0 m)	N1294A-012	

#### Step 2-4. Determine if you use the series with multiple software control options (optional)

The series has multiple software control options, allowing you to choose the solution that best fits your particular application.

Software Control Option	Available interface	Description
PathWave BenchVue	GPIB, USB, LAN	Source constant voltage or current and control other Keysight instruments
Graphical Web Interface	LAN	Use your web browser to make basic measurements
PW9251A PathWave IV Curve Software	GPIB, USB, LAN	Easy-to-use GUI software for IV measurement without programming
EasyEXPERT group+	GPIB, USB, LAN	Powerful software for detailed characterization and analysis of devices, circuits and materials

- 82357B GPIB-USB Interface is required for software control through GPIB interface.
- 1.8 m USB cable is furnished with the B2900B/BL series for software control through USB interface.
- LAN cable is required for software control through LAN interface.
- The EasyEXPERT group+ software supports multiple unit control with synchronization. Please see the next page in detail.

#### Step 2-5. Determine if you use the B2900B/BL SMUs with EasyEXPERT group+ software

The EasyEXPERT group+ software is capable to control up to 4 units of the B2900B/BL SMUs at the same time. It is required to make a connection of trigger lines in order to synchronize one unit to the others when you use multiple units of the B2900B/BL SMUs with the EasyEXPERT group+ software. GPIB, USB or LAN connection can use to synchronize multiple units with N1294A-032.

1. Use a single unit of the B2900B/BL SMU

**Recommended accessories for synchronization**

B2900B/BL	1ea	Precision Source/Measure Unit
82357B	1ea	USB/GPIB interface

2. Use a two unit of the B2900B/BL SMU

**Recommended accessories for synchronization**





B2900B/BL	2ea	Precision Source/Measure Unit
82357B	1ea	USB/GPIB interface
N1294A-032	1ea	Digital I/O Trigger Cable for Multiple Unit Control
10833D	1ea	GPIB cable (0.5 m)

3. Use a three unit of the B2900B/BL SMU

**Recommended accessories for synchronization**

B2900B/BL	3ea	Precision Source/Measure Unit
82357B	1ea	USB/GPIB interface
N1294A-032	1ea	Digital I/O Trigger Cable for Multiple Unit Control
10833D	1ea	GPIB cable (0.5 m)

#### 4. Use 4 units of the B2900B/BL SMUs

Recommended accessories for synchronization				
				
B2900B/BL	4ea	Precision Source/Measure Unit		
82357B	1ea	USB/GPIB interface		
N1294A-032	1ea	Digital I/O Trigger Cable for Multiple Unit Control		
10833D	1ea	GPIB cable (0.5 m)		





The EasyEXPERT group+ software manuals (User's Guide) are available for download from [www.keysight.com/find/easyexpert](http://www.keysight.com/find/easyexpert). If you need printed manuals then they can be ordered using the part numbers shown below.

Description	Product number	Additional Information
Paper Manual (User's Guide), English	B1540-90009	Printed copy, Volume 1 for EasyEXPERT group+
	B1540-90023	Printed copy, Volume 2 for EasyEXPERT group+
Paper Manual (User's Guide), Japanese	B1540-97009	Printed copy, Volume 1 for EasyEXPERT group+
	B1540-97023	Printed copy, Volume 2 for EasyEXPERT group+

#### Step 2-6. Select additional accessories (optional)

The following optional accessories are available for specialized requirements.

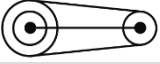
Description	Product number	Additional Information
Low leakage Triaxial cable (1.5 m)	16494A-001	16494A triaxial cable supports up to 200 V and 1 A.
Low leakage Triaxial cable (3.0 m)	16494A-002	
Low leakage Triaxial cable (0.8 m)	16494A-003	
Low leakage Triaxial cable (0.4 m)	16494A-004	
Low leakage Triaxial cable (4.0 m)	16494A-005	
High Current Triaxial cable (1.5m)	16493L-001	16493L triaxial cable supports current higher than 1 A.
High Current Triaxial cable (3.0m)	16493L-002	
Coax cable (1.5 m)	16493B-001	16493B coax cable supports up to 40 V and 200 mA.
Coax cable (3.0 m)	16493B-002	
High Current BNC Coax cable (1.5 m)	16493U-001	16493U coax cable supports up to 40 V and 20 A pulse.
High Current BNC Coax cable (3.0 m)	16493U-002	
Coaxial BNC cable (1.2 m)	U2921A-100	
Combo test lead kit	U8201A	
Kelvin probe set	11059A	

Description	Product number	Additional Information
Triaxial(m) to BNC (f) adaptor	N1254A-101	
Triaxial(f) to BNC (m) adaptor	N1254A-102	
Triaxial(m) to BNC (f) adaptor	N1254A-103	
Triaxial (f) to BNC (m) adaptor	N1254A-104	
Triaxial (f) to BNC (m) adaptor	N1254A-105	
Triaxial (m) to BNC (f) adaptor	N1254A-106	
Triaxial (m) to Triaxial (f) adaptor	N1254A-107	
sCoax Tee Adapter (m-f-f)	1250-2405	
Triaxial Tee Adapter (f-m-f)	1250-1551	
Digital I/O cable (1.5 m)	16493G-001	To synchronize triggering between member of the B2900B/BL Series
Digital I/O cable (3.0 m)	16493G-002	
Digital I/O T-cable	N1253A-100	To synchronize triggering between member of the B2900B/BL Series
Interlock cable (1.5 m)	N1294A-011	Interlock cable for the 16442A/B test fixture (GPIO Dsub-25 to 6-pin mini plug)
Interlock cable (3.0 m)	N1294A-012	
GPIO - BNC Trigger Adapter	N1294A-031	
Digital I/O Trigger Cable for Multiple Unit Control	N1294A-032	Required to use EasyEXPERT group+ software with multiple units
USB A-B-I-O Cable (2.0 m)	8121-1696	USB A-B I-O cable
USB/GPIB interface	82357B	
Banana - Triaxial Adapter for 2-wire (non Kelvin) connection	N1297A	
Banana - Triaxial Adapter for 4-wire (Kelvin) connection	N1297B	
Device/component test fixture	N1295A	
Test Fixture for E5270 and general use	16442B	
GPIB cable (1.0 m)	10833A	
GPIB cable (2.0 m)	10833B	
GPIB cable (4.0 m)	10833C	
GPIB cable (0.5 m)	10833D	

### Step 3. Select warranty length and calibration plan (optional)

Keysight factory calibration is provided as standard and free of additional charges.

Description	Product number	Additional Information
Calibration + uncertainties + guardbanding (not accredited)	B2901BL-1A7	Calibration certificate with measurement results available only at time of purchase
	B2910BL-1A7	
	B2901B-1A7	
	B2902B-1A7	
	B2911B-1A7	
	B2912B-1A7	
ANSI Z540-1-1994 calibration	B2901BL-A6J	Calibration certificate with measurement results available only at time of purchase
	B2910BL-A6J	
	B2901B-A6J	
	B2902B-A6J	
	B2911B-A6J	
	B2912B-A6J	
Commercial calibration certificate with test data	B2901BL-UK6	Calibration certificate with measurement results available only at time of purchase
	B2910BL-UK6	
	B2901B-UK6	
	B2902B-UK6	
	B2911B-UK6	
	B2912B-UK6	
Calibration plan — return to Keysight — 3 years	R-50C-011-3	
Calibration plan — return to Keysight — 5 years	R-50C-011-5	

## Software Upgrade Package for B2900B/BL Series

If you don't have the license for the EasyEXPERT group+ software or latest functions on GUI with your existing B2900B/BL Series, a product update may be required. Please contact Keysight in detail.

Description	Product number	Additional Information
B2901BL software upgrade package	B2901BLU	Extension support and subscription
B2910BL software upgrade package	B2910BLU	
B2901B software upgrade package	B2901BU	
B2902B software upgrade package	B2902BU	
B2911B software upgrade package	B2911BU	
B2912B software upgrade package	B2912BU	

Learn more at: [www.keysight.com](http://www.keysight.com)

For more information on Keysight Technologies' products, applications or services, please contact your local Keysight office. The complete list is available at: [www.keysight.com/find/contactus](http://www.keysight.com/find/contactus)

